



# KAT

A SUPERIOR ANIMAL ALTOGETHER.

## Kawneer Aluminium Bifold Doors

WITH 7 COLOURS FROM STOCK TO CHOOSE FROM,  
**KAT MAKES IT HOME**



# Kawneer Aluminium - Bifold Door



## Features

---



- Thermally broken aluminium bifold door system
- From 1 to 7 panels in various configurations
- Slim sightlines, no floating mullions
- Inward or outward opening
- Standard fully weathered threshold 45mm
  - Low threshold option (24mm)
- Multipoint locking system to master door
- 3 star diamond security rated cylinder with Kitemark
  - PAS24:2016 enhanced security available
- Discreet lever handle to intermediate doors
- 7 colour options from stock
  - Black anodised finish available
- Chamfered 28mm glazing bead as standard
  - 28mm, 32mm & 44mm square bead options:36mm chamfered bead option
- Sits on 95mm, 150mm and 174mm cills

# Kawneer Aluminium - Bifold Door

## Colour options

---

7 colours from stock with a 2 week lead time :

### Single colours

- Black, White, Anthracite Grey, Textured Slate Grey, Light Grey

### Dual colours

- Black out/White in and Anthracite Grey out/White in

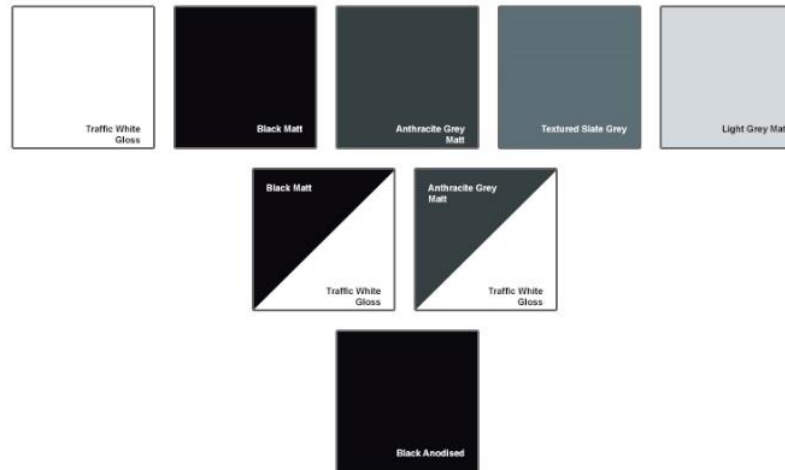

- Marine Grade Black Anodised finish available



# Kawneer Aluminium - Bifold Door

## Furniture colour options

---



- Master handles with design exclusive to KAT. Available in White, Grey, Black, Chrome, Gold and Brushed Steel
- Master handles carry a 10 year guarantee
- Locking intermediate lever handle available in White, Black, Chrome and Brushed Steel finish.



# Kawneer Aluminium - Bifold Door

## Door configurations

### Configuration options

All style numbers shown below can be manufactured to open in the opposite direction. For example, style 3-2-1 can be reverse handed to 3-1-2.

# On these styles, there is no traffic door and doors can only be opened from the inside of the property.

2 - 0 - 2 #

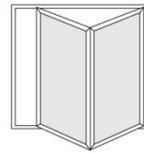

3 - 3 - 0

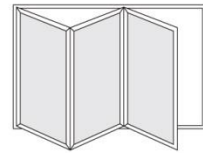

3 - 2 - 1

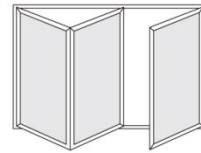

4 - 1 - 3

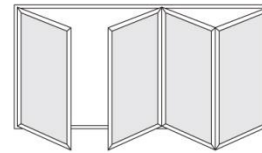

4 - 4 - 0 #

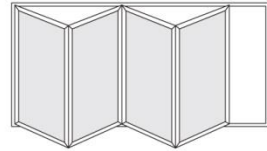

4 - 2 - 2 #

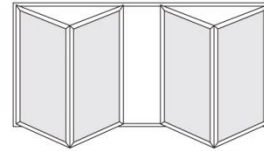

5 - 5 - 0

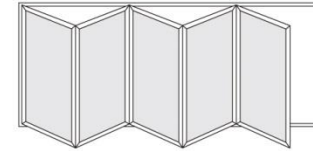

5 - 4 - 1

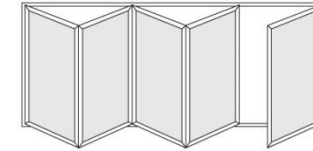

5 - 3 - 2

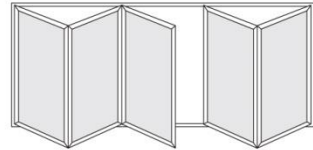

6 - 1 - 5

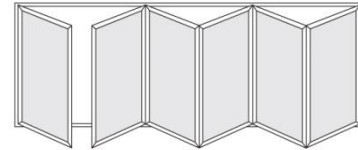

6 - 3 - 3

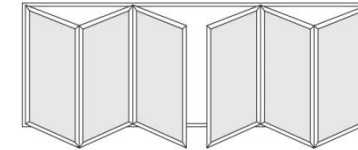

6 - 6 - 0 #

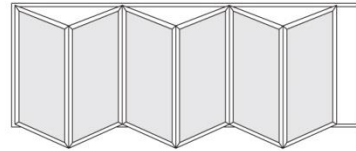

6 - 2 - 4 #

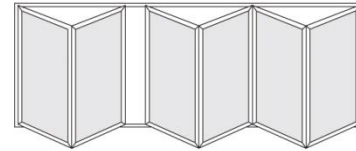

7 - 7 - 0

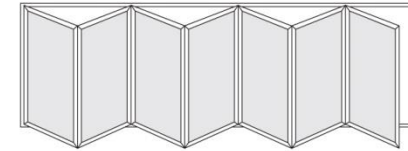

# Kawneer Aluminium - Bifold Door



## Size limits

---



	Maximum	Minimum
Height	2930mm depends on width	1930mm
Overall width	10000mm	1500mm based on 2 panels
Panel width	1200mm	700mm
Weight per panel	120 Kgs	

For doors greater than 6.4 metres, outerframe will be provided as a mechanically jointed kit

# Kawneer Aluminium - Bifold Door

## Mechanical joint option

---

- Doors are fabricated and fully assembled as standard
- Outer frames can be supplied mechanically jointed as an option
- Outer frames will be supplied in kit form for doors greater than 6.4m in width or 2.2m in height
- Full installation instructions available



# Kawneer Aluminium - Bifold Door



## Bifold detail

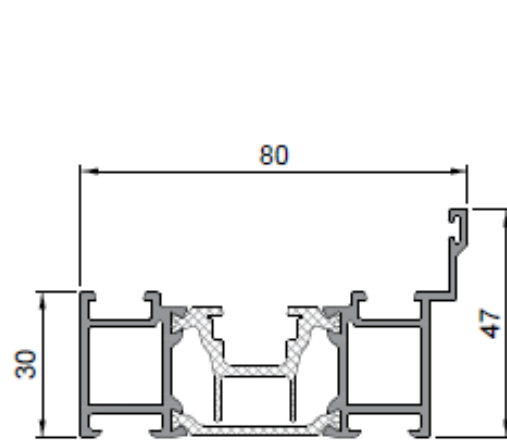

**3001 512**  
Rebated head/jamb  
6700mm stock length

Rebated head/jamb

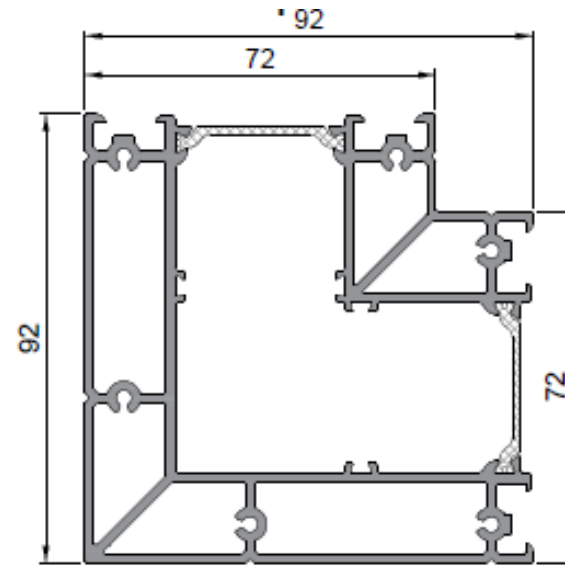

Corner post (option)

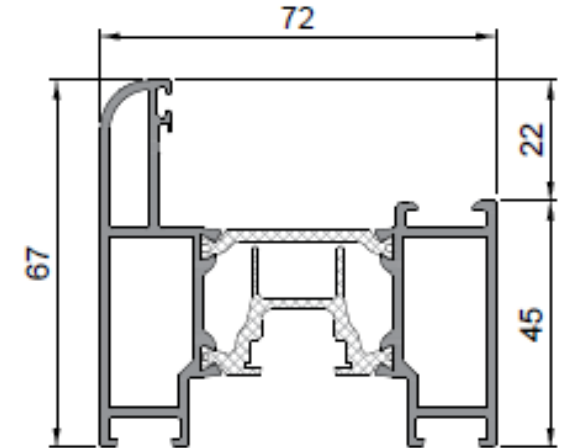

Door sash/vent

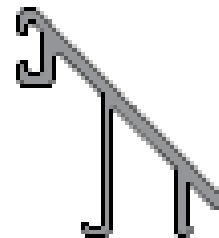

28mm Chamfered bead



# Kawneer Aluminium - Bifold Door

## Frame edge detail

- 72mm edge detail
- Universal coupler & range of ancillaries
- 45mm fully weathered threshold
  - 24mm low threshold option (not severe weather rated)

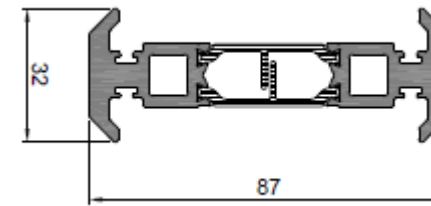
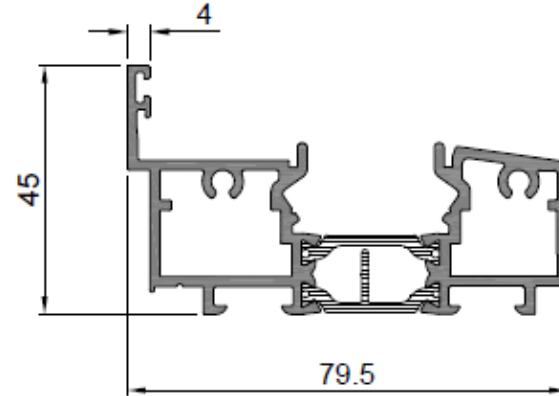

15mm coupler

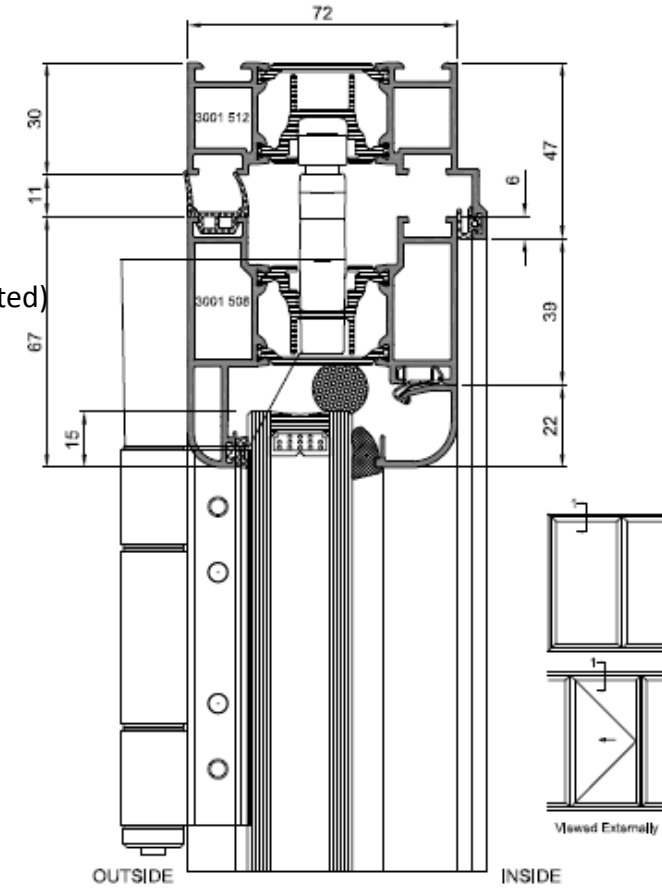
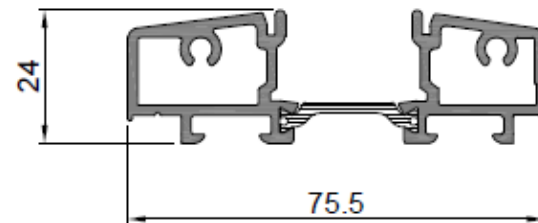

# Kawneer Aluminium - Bifold Door



## Threshold Options

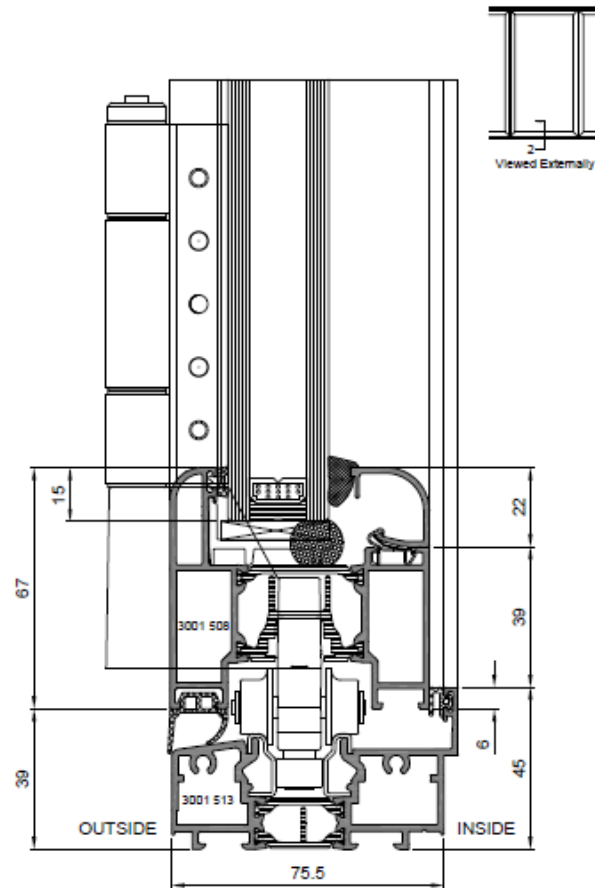

Standard threshold (with full weather rating)

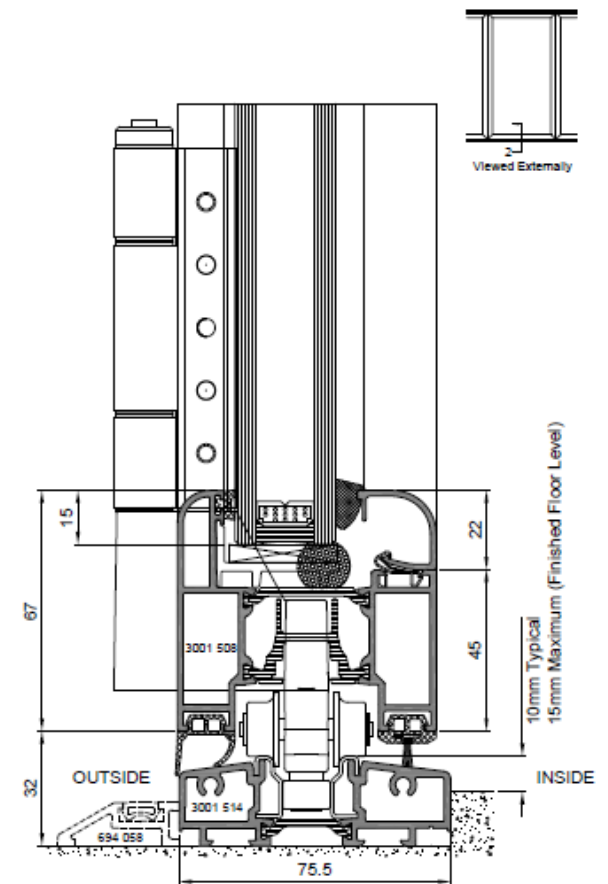

Low threshold (not severe weather rated)

# Kawneer Aluminium - Bifold Door

## Cill Options

---

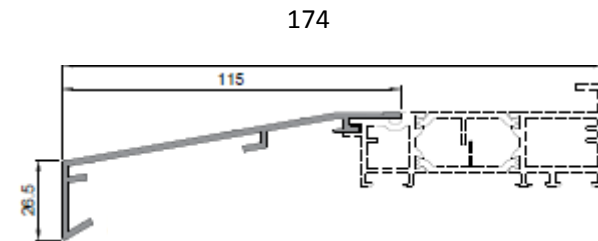
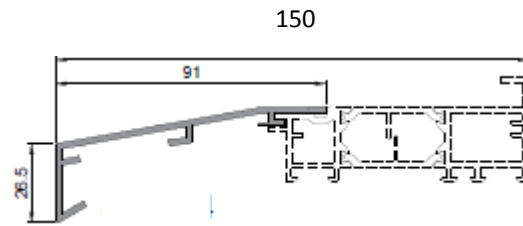
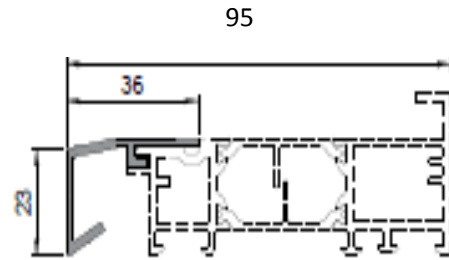

- 95mm, 150mm and 175mm cills

# Kawneer Aluminium – Bifold Door

## Hardware

---

- Sobinco hook lock to the master door – 5 point locking
- Stainless steel track
- Rollers designed to take 120Kgs per sash
- Magnetic door catches
- Lockable lever handle on intermediate door
- Doors with slave leaf operated with finger bolts
- PAS24:2016 enhanced security available



Magnetic door catches



Intermediate handle

# Kawneer Aluminium - Bifold Door



## Weather rating

---



- Low U Value – with DGU of 1.0 centre pane value, full door indicative U Value of 1.4 W/m<sup>2</sup>K°
- U Value of 1.0 W/m<sup>2</sup>K° achievable with 0.5W/m<sup>2</sup>K° triple glazed unit
- Leading the industry for weather rating
  - Air Class 3 600 Pascals
  - Wind Class A5 1600 Pascals
  - Water Class E750 750 Pascals

# Kawneer Aluminium Bifold Door



## U Values



Part L1B/L2B	OPEN IN OR OPEN OUT FSD					
	Panel Variant					
Glass U Value (W/m <sup>2</sup> K)	2 Panel	3 Panel	4 Panel	5 Panel	6 Panel	
1.2	1.54	1.52	1.51	1.50	1.50	
1.1	1.47	1.44	1.44	1.43	1.43	
1.0	1.40	1.37	1.36	1.35	1.35	
0.9	1.32	1.29	1.29	1.28	1.28	Door U Value
0.8	1.25	1.22	1.21	1.20	1.20	
0.7	1.18	1.15	1.14	1.13	1.12	
0.5	1.03	1.0	0.99	0.98	0.97	

# Kawneer Aluminium - Bifold Door



## Summary

---



- Thermally broken aluminium bifold door system
- From 1 to 7 panels in various configurations
- Slim sightlines, no floating mullions
- Inward or outward opening
- Standard fully weathered threshold 45mm
  - Low threshold option (24mm)
- Multipoint locking system to master door
- 3 star diamond security rated cylinder with Kitemark
  - PAS24:2016 enhanced security available
- Discreet lever handle to intermediate doors
- 7 colour options from stock
  - Black anodised finish available
- Chamfered 28mm glazing bead as standard
  - 28mm, 32mm & 44mm square bead options:36mm chamfered bead option
- Sits on 95mm, 150mm and 174mm cills



BIFOLD DOORS | PATIO DOORS | RESIDENTIAL DOORS  
BOX SASH WINDOWS | CASEMENT WINDOWS  
LANTERN ROOFS | FLAT ROOF LIGHTS  
**KAT MAKES IT HOME**



**TELL ME ABOUT KAT**

**KAT UPVC DOORS  
& WINDOWS**

**KAT ALUMINIUM  
DOORS & WINDOWS**

**KAT ROOF GLAZING**

Call: **01625 439666**  
Visit: **[www.katuk.co.uk](http://www.katuk.co.uk)**